

Article number: 4395000281

Description: Rota-fix shaft-hub connection F28x55  
Stainless steel

## Measures

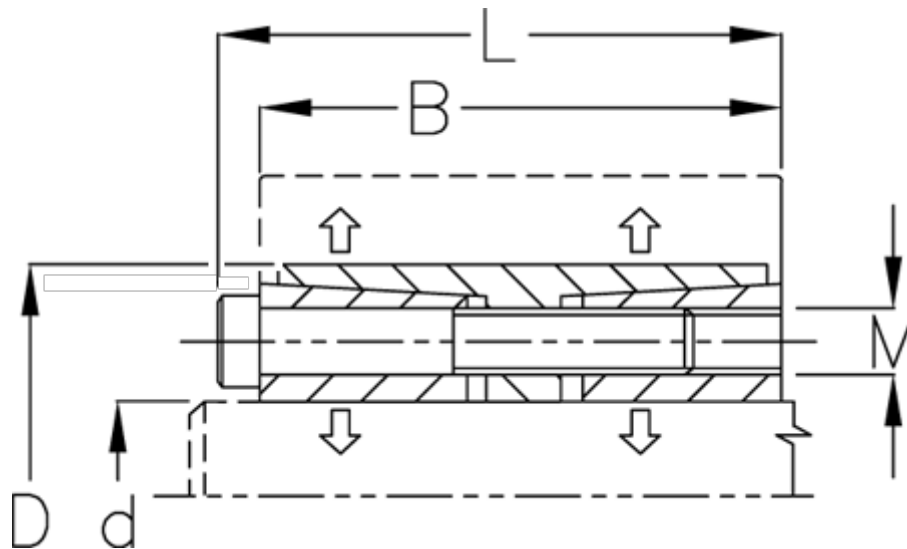

B mm	= 40
d H8 mm	= 28
D mm	= 55
Fit tolerance	= Aksel h8, Nav H8
F kN torque	= 35.4
L mm	= 46
M mm	= M6
P N/mm <sup>2</sup> surface pressure on shaft/hub	= 34

Surface roughness	= R? ? 3.2 µm
T N m torque	= 490
Ts N m bolt tightening torque	= 11.8